

BG-VPTZN-HSU3

**PTZ Full HD 1080P 10X/20X/30X Zoom HDMI/SDI/USB 3.0/IP
Live Streaming Camera with POE and NDI**

User Manual







Table of Contents

Safety Precaution	4
Features	5
Packing List	6
Specifications	7
Operation Controls and Functions	8
Remote Control	11
Operation Instructions	12
Menu Settings	14
Network Connection	18
Camera Web Interface	22
Application Example	30
Installation Instructions	31
Tech Support	32
Warranty	32
Mission Statement	32
Copyright	32



Statement

Please read these instructions carefully before connecting, operating, or configuring this product. Please save this manual for future reference.

Safety Precaution

- To prevent damaging this product, avoid heavy pressure, strong vibration, or immersion during transportation, storage, and installation.
- The housing of this product is made of organic materials. Do not expose to any liquid, gas, or solids which may corrode the shell.
- Do not expose the product to rain or moisture.
- The product has no power switch. Remove power immediately if camera is not in proper working condition to avoid electrical shock.
- To prevent the risk of electric shock, do not open the case. Installation and maintenance should only be carried out by qualified technicians.
- Do not use the product beyond the specified temperature, humidity, or power supply specifications.
- This product does not contain parts that can be maintained or repaired by users. Damage caused by dismantling the product without authorization from BZBGear is not covered under the warranty policy.
- Installation and use of this product must strictly comply with local electrical safety standards.
- Do not turn camera head manually. Doing so may result in mechanical damage. Camera should only be placed on a stable horizontal surface and cannot be installed at an angle.
- Make sure there are no obstacles within the camera's rotational range when installing. Never power on before installation has been completed.



Introduction

The BG-VPTZN-HSU3 is a compact 1080p HD PTZ camera with NDI|HX. Designed with a small footprint to unobtrusively blend into offices and classrooms, this performer is equipped with simultaneous HDMI, 3G-SDI, USB 3.0, NDI|HX / IP streaming outputs. The camera also supports H.264 and H.265 video compression formats, and can broadcast in ONVIF, RTSP, and RTMP IP streaming protocols.

The BG-VPTZN-HSU3 camera can capture clear images at resolutions up to 1080p@60Hz thanks to a high signal to noise ratio CMOS sensor. The built-in 3.5mm audio input jack allows the BG-VPTZN-HSU3 to embed audio directly into the video stream for easier production.

NDI® (Network Device Interface) technology which provides the ability for multiple video systems to communicate via a local area network (LAN) and eliminates the requirement for video cables like HDMI, DVI, and SDI for streaming, providing convenience and versatility. The technology was developed by NewTek™ to simplify remote connections, streaming, capture/playback, replay, and production.

NDI cameras support bi-directional communication featuring ultra-low latency and ultra-high video streams on shared connections. To function properly, the network needs to support 1GB throughput using at least CAT5/6 cables for connectivity. Software programs offering NDI capture will also typically require a NDI plugin to be installed.

The BG-VPTZN-HSU3 camera can be controlled using RS-232, RS-485, LAN, or IR remote control. There are 255 available preset positions that can be stored internally, with nine of those presets being available via IR remote control. These features, small size, and quiet operation make the BG-VPTZN line of cameras ideal for education, conferencing, houses of worship, and telemedicine, where space may be limited but thanks to the BG-VPTZN your options are not!



Features

- **1080P Full High-definition:** 1/2.8" high quality CMOS sensor (1/2.7" sensor on 10x), can reach maximum 1920 x 1080 resolutions and output frame rate up to 60fps.
- **NDI|HX:** Allows the camera to be powered, controlled, and its video output through just one CAT 5e/6/7 cable greatly simplifying installation.
- **10/20/30X Optical Zoom with 72°/65°/65.4° horizontal field of view:** Equipped with advanced image processing technology and a full HD 1/2.8" CMOS Sensor (1/2.7" sensor on 10x), 10/20/30X Optical Zoom, and a maximum resolution of 1080P@60fps.
- **Low Video Noise:** The inclusion of a high SNR (Signal to Noise Ratio) CMOS sensor combined with 2D and 3D noise reduction functions reduces video noise to provide a clear image, even under low-light conditions.
- **Multiple Simultaneous Outputs:** Equipped with simultaneous USB 3.0, 3G-SDI, HDMI, NDI|HX, and 4 channels of IP streaming outputs (RTSP/RTMP/RTMPS).
- **Quiet Pan and Tilt Movement:** High-precision stepper motors and an advanced motor drive processor ensure smooth, quiet, and responsive camera movement.
- **Multiple Control Options:** The camera can be operated via RS232, RS485, LAN, or IR remote control. Supported protocols include VISCA, PELCO-P/D, ONVIF, and VISCA over IP.
- **Preset Image Freeze:** When enabled, this function captures a still image and holds it until the camera has moved to the next selected preset, eliminating jarring transitions.
- **Multi-preset:** Supports up to 255 presets. (Remote control can only set and recall 9 presets.)
- **Suitable for a wide variety of applications:** The compact footprint makes this camera an ideal fit for education, conferencing, telemedicine, houses of worship, and any other scenario where space is limited but high- quality video is required.
- **Multiple Network Protocols:** Supports NDI|HX, ONVIF, RTSP, RTMP, and RTMPS protocols.

Packing List

- 1x BG-VPTZN-HSU3 Camera
- 1x IR Remote Controller
- 1x RS-232 to DB 9-pin cable
- 1x 12V 2.0 A DC Power Adapter
- 1x User Manual



Specifications

Model	BG-VPTZN-10HSU3	BG-VPTZN-20HSU3	BG-VPTZN-30HSU3
Camera Parameters			
CMOS Sensor	1/2.7" Exmor CMOS	1/2.8" Exmor CMOS	1/2.8" Exmor CMOS
Effective Pixels	2.7 Megapixels	2.38 Megapixels	2.7 Megapixels
Video Format	1080P60/59.94/50/30/29.97/25;1080I60/59.94/50/30/29.97/25;720P60/50/30/25,480I60,576I50		
Optical Zoom	10X Optical; 12X Digital Zoom	20X Optical; 12X Digital Zoom	30X Optical; 12X Digital Zoom
Focus	f=5.1mm~51mm	f=4.7mm~94.0mm	f=5.2mm~148.4mm
HOV	72°	65°	65.4°
F-number	F=1.6(W)-3.5(T)	F=1.6(W)-3.5(T)	F=1.3(W)-4.8(T)
Min. Illumination	0.005Lux (F1.8,AGC:ON)		
Digital Noise Reduction	2D & 3D		
White Balance	Auto/Manual/Indoor/outdoor/White Balance/3000K/4000K/5000K/6500K		
Focus	Auto/Manual		
Iris	Auto/Manual		
Backlight Compensation	1-7/Off		
Control Panel	Brightness, Hue, Saturation, Contrast, Sharpness		
Interface Parameters			
Video Output Interface	HDMI, 3G-SDI, IP Streaming, USB 3.0, NDI HX		
Video Network Coding	H.265, H.264, MJPEG		
Communication	1x RS232 IN, 1x RS232 Out, 1x RJ45, RS485		
Control Protocol	VISCA/PELCO-D/PELCO-P/Visca Over IP/ONVIF		
Baud Rate	2400/4800/9600/115200		
Audio Input	1-ch 3.5mm audio interface, Line In		
Audio Compression Format	G.711, G.722, G.722.1, G.728, G.722.1C AAC		
Network Interface	100M internet access (10/100BASE-TX)		
Network Protocol	NDI HX, TCP/IP, HTTP, RTSP, RTMP, RTMPS, ONVIF, DHCP, Multicast		
Power Interface	JEITA type (DC IN 12V)/POE		
Mechanical Parameters			
Pan Rotation Angle	-178° - +178°		
Vertical Angle of View	-30° - +90°		
Pan Speed Range (per sec)	0.1~180°/s		
Tilt Speed Range (per sec)	0.1-120%		
Presets	255		
Other Parameters			
Power Adapter	AC100V-AC240V in, DC12V/2A out		
Input Voltage	DC 12V		
Power Consumption	12W		
Storage Environment	-10°C - +60°C / 20% - 95%		
Working Environment	-10°C - +50°C / 20% - 80%		
Dimensions (L x W x H)	4.7in x 4.7in x 5.7in [120mm x 120mm x 145mm]		
Gross Weight	3.5 lbs [1.6kg]		
Working Environment	Indoor Only		
Optional Accessories	Wall mount (BG-VPTZ-WM); Ceiling mount (BG-VPTZ-CM)		



Operation Controls and Functions

Connections Overview

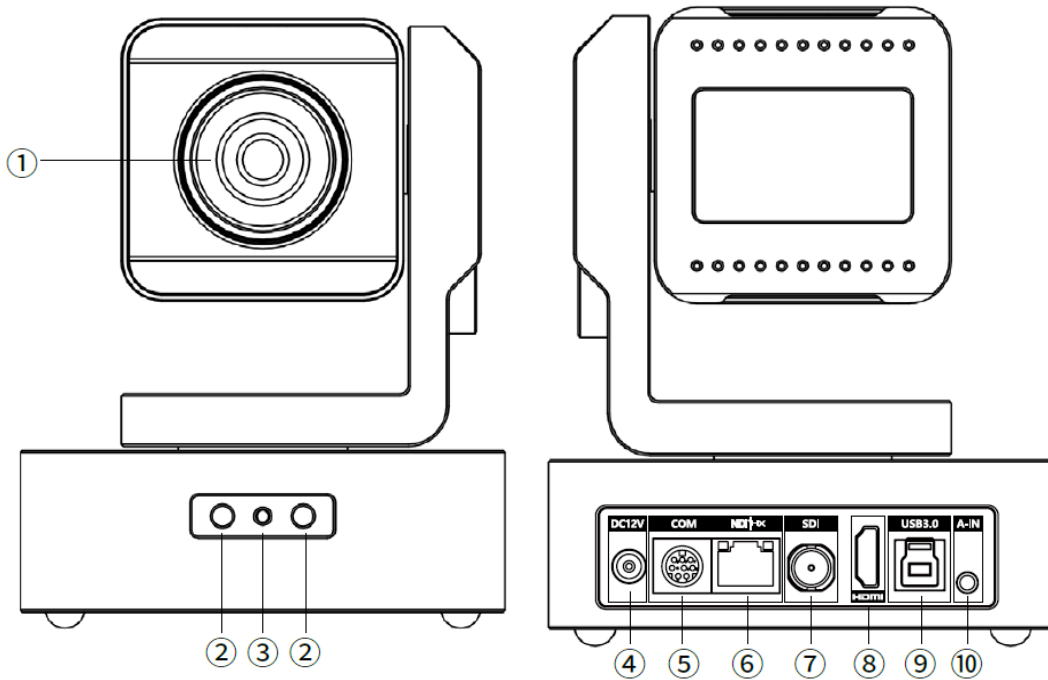

No.	Name
1	IR Lens
2	IR Receiver
3	Power Indicator
4	DC12V Input
5	COM Port (RS485/RS232)
6	RJ45 IP Streaming, NDI HX, PoE
7	3G-SDI Output
8	HDMI Output
9	USB 3.0 Type-B
10	3.5mm Audio-Input



RS232 Interface Specifications

For serial connection to computers or joystick controllers.

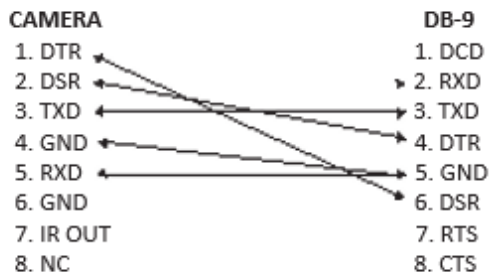
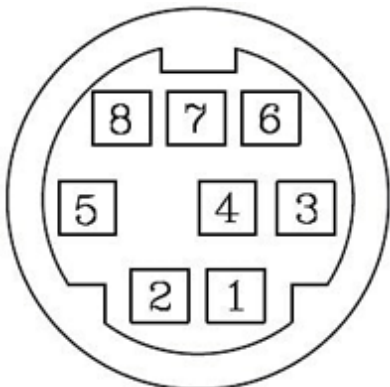

RS232 INPUT		
NO.	Function	Definition
1	DTR	Data Terminal Ready
2	DSR	Data Set Ready
3	TXD	Transmit Data
4	GND	Ground
5	RXD	Receive Data
6	GND	Ground
7	IR OUT	IR Signal Output
8	NC	No Connection

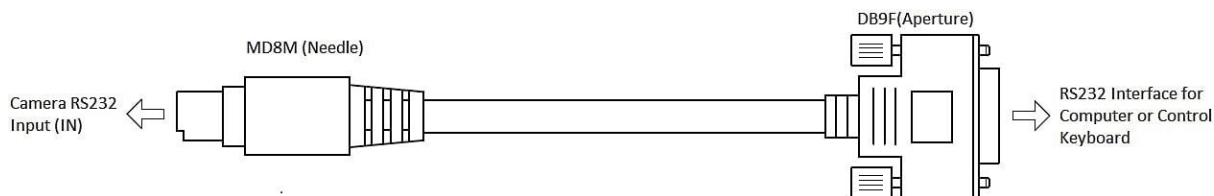
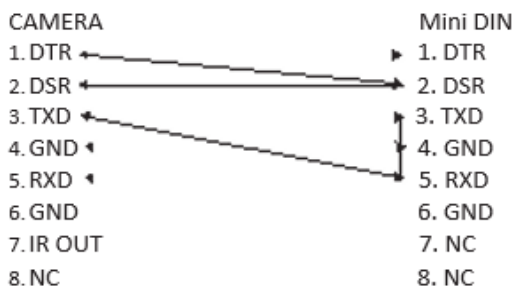



Camera Dimensions

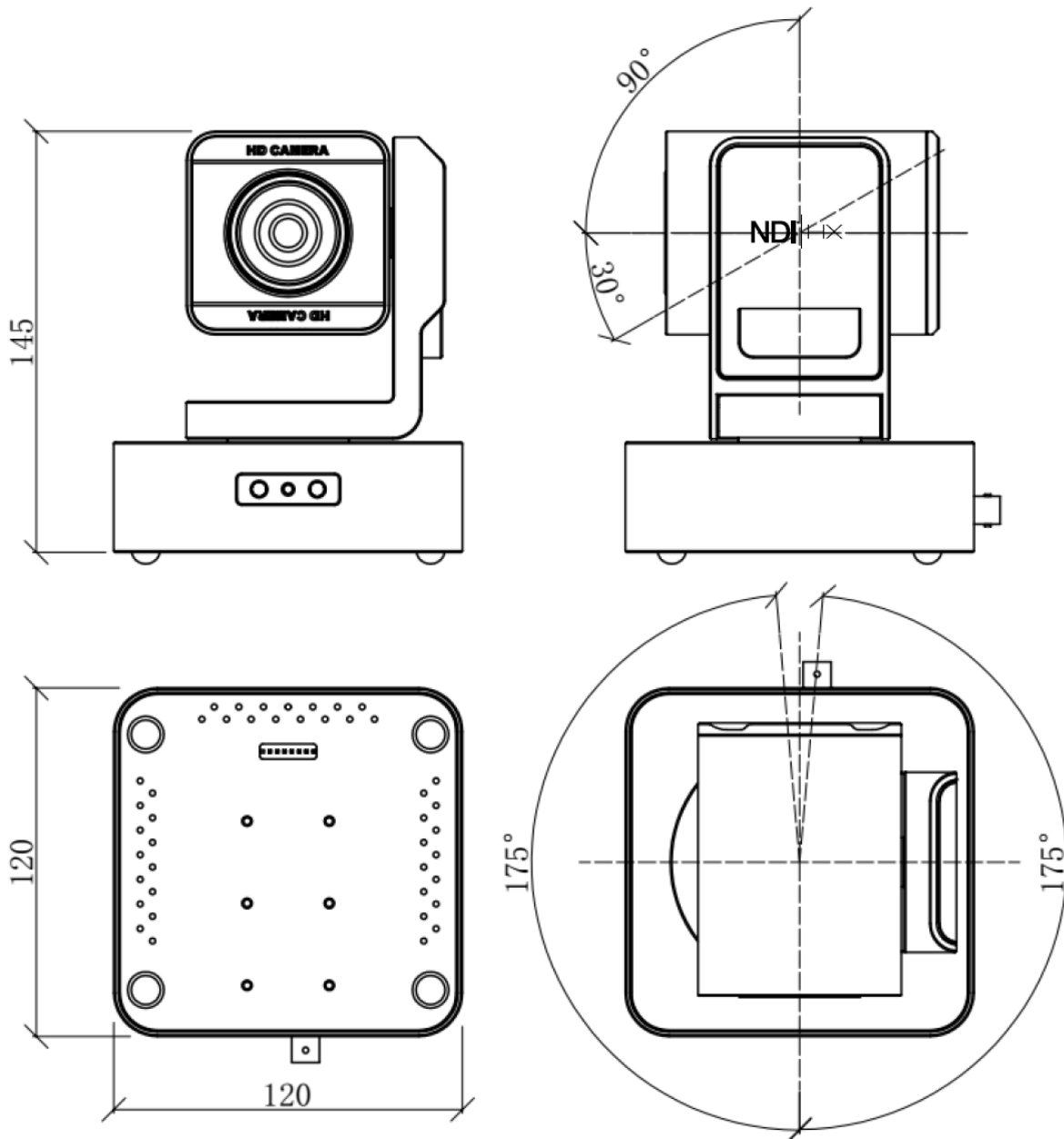



Remote Control

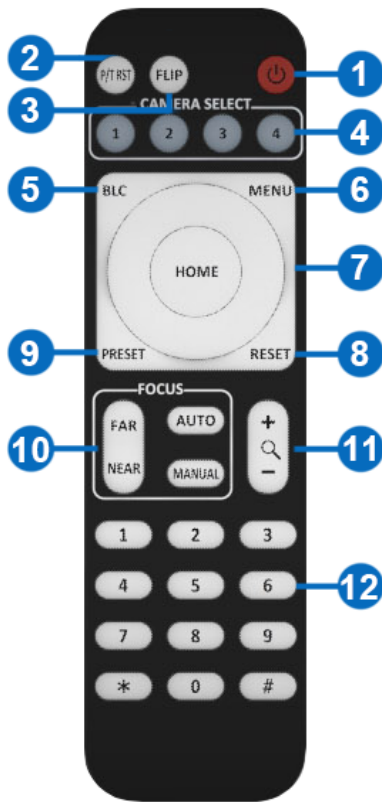

No.	Key	Function
1	Power Key	After pressing, the camera enters standby mode
2	P/T RST Key	After pressing, the camera enters self-check
3	Flip Key	Flip the camera image
4	Camera Select Key	Select the camera to be controlled
5	BLC Key	Turn on/off BLC
6	Menu Key	Enter/Exit Menu
7	Camera PTZ Control Key	Press the HOME button to return the camera to the center position
8	Preset Erase Key	Press "Reset"+ Number (1-9)to erase the corresponding Preset
9	Preset Setting Key	Press "Preset"+ Number (1-9)to save the corresponding preset
10	Focus Key	[AUTO]: Automatic focus [MANUAL]: Manual focus [FAR]: Manual focus on distant objects [NEAR]: Manual focus on nearby objects
11	Zoom Key	+ increase, - decrease
12	Number Key	Used for setting and recalling Presets

Note: Always maintain a direct and unobstructed line of sight between the remote control and the sensor on the front of the camera.



Operation Instructions

Camera ID Select



Select the target camera ID (from No.1 to No.4)

Pan/Tilt Control



Move camera lens up ▲

Move camera lens down ▼

Move camera lens to the left ◀

Move camera lens to the right ▶

Return camera lens to center [HOME]

Tip: Pressing the directional button will rotate the camera lens slowly. Pressing and holding the button will rotate it faster.

Menu Display

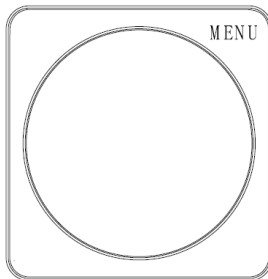

Click the [MENU] button to display the on-screen menu. To exit, press [MENU] again.

Focus

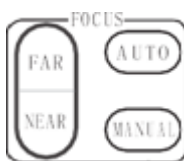

[AUTO] Enable auto focus

[MANUAL] Switch to manual focus mode

[FAR] Manually focus on a distant object

[NEAR] Manually focus on a nearby object

Back Light Compensation

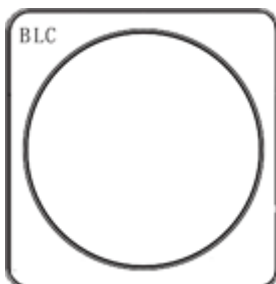

Strong background light can create unwanted shadows.

Press [BLC] to activate backlight compensation mode.

Press [BLC] again to deactivate.



Zoom



Click the [+] Button, to zoom in.
 Click the [-] Button, to zoom out.

Setting, Recalling, and Erasing Presets

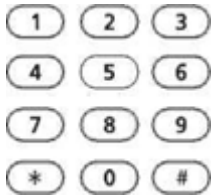

To save a preset, press [PRESET] then press any of the numbers (no. 1-9). You can save up to 9 presets.

To call a preset, press the saved preset number (no. 1-9).

To reset a preset, press [RESET] then press the preset number (no. 1-9) you want to reset.

Image Flip & P/T Reset

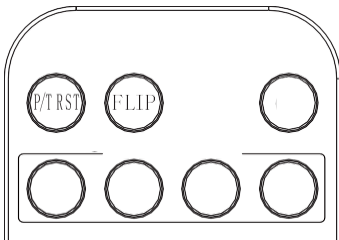

Click the [FLIP] button to invert the image for ceiling applications.

Click the [P/T RST] button to automatically recalibrate the PTZ controls.



Menu Settings

1. Press the [MENU] button on the remote control to display the OSD menu.
2. Use the arrow keys to navigate the menu, press left and right buttons to adjust the settings.



Exposure

Press the [MENU] button to display the OSD menu, press arrow keys to highlight EXPOSURE and then press right to enter the sub-menu.

- [AE MODE]: AUTO/SHUTTER/IRIS/BRIGHT/MANUAL
- Press right button to select options as defined below:
- [AE LEVEL]: Changes depending on selected AE MODE (Not available in AUTO Mode)
 - Manual Mode Only
 - [SHUTTER]: Shutter priority mode: 1/1 - 1/10000
 - [IRIS]: priority mode: F1.6 - F24
 - [GAIN] -3DB - 28DB
- [EXPCOMP]: -10.5DB - +10.5DB / OFF
- [HLC]: 0-15
- [BACKLIGHT]: 1-7 / OFF
- [FLICKER]: 50HZ, 60HZ, OFF





Color

Press the [MENU] button to display the OSD menu, press arrow keys to highlight COLOR and then press right to enter the sub menu.

- [WB MODE]: AUTO/INDOOR/OUTDOOR/
OPW/ATW/MANUAL/3000K/
4000K/5000K/6500K
- [SATURATION]: 60%-200%
- [COLOR HUE]: 0-14
- [RED GAIN]: 0-255
(MANUAL mode only)
- [BLUE GAIN]: 0-255
(MANUAL mode only)



Picture

Press the [MENU] button to display the OSD menu, press the arrow keys to highlight [PICTURE] and then press the right button to enter the sub-menu.

- [BRIGHT]: 0-14
- [CONTRAST]: 0-14
- [SHARPNESS]: 0-15
- [ICR]: COLOR/BLACK
- [STYLE]: STANDARD/BRIGHT/RTSP/SOFT
- [GAMMA]: 0-9





P/T/Z

Press the [MENU] button to display the OSD menu, then press the arrow keys to highlight [P/T/Z] and press right to enter the sub-menu.

- [FLIP]: ON/OFF (flips image vertically)
- [L/R DIRECTION]: ON/OFF (changes L/R controls for when image is flipped)
- [AF MODE]: AUTO/MANUAL/Z Trigger
- [AF SENS]: NORMAL/LOW
- [PRESET FREEZE]: ON/OFF
- [PRESET SPEED]: 1-24



Noise Reduction

Press the [MENU] button to display the OSD menu, press the arrow keys to highlight [NOISE REDUCTION], then press right to enter the sub-menu.

- [2D NR]: 0-5 / OFF
- [3D NR]: 0-5 / OFF
- [DYN HOT PIXEL]: ON/OFF



Video Format

Press the [MENU] button to display the OSD menu, press the arrow keys to highlight [VIDEO OUT], then press right to enter the sub-menu.

- [VIDEO OUT]:
1080P60/59.9 4/50/30/29.97/25
1080I60/59.94/50
720P/60/59/50
- [REBOOT]: Reboots the camera
- [UVC]: ON / OFF (enables USB video output, OFF by default)
- [DIGITAL AUDIO]: ON / OFF (embed audio from 3.5mm stereo mini)





System Setup

Press the [MENU] button to display the OSD menu, press the arrow keys to highlight [SYSTEM SETUP], then press right to enter the sub-menu.

- [SYSTEM INFO]: press right button to the sub menu, as the right picture shown
- [LANGUAGE]: ENGLISH/CHINESE
- [ZOOM LABEL]: ON/OFF
- [PROTOCOL]: VISCA/PELCO-D/PELCO-P
- [ADDRESS]: 1-255 / AUTO
- [BAUDRATE]: 2400/4800/9600/19200/38400

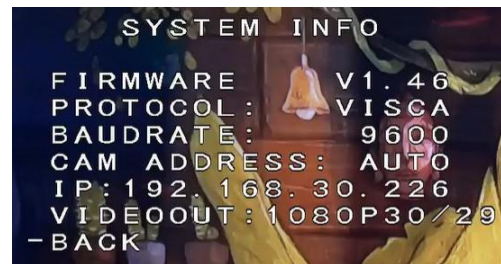
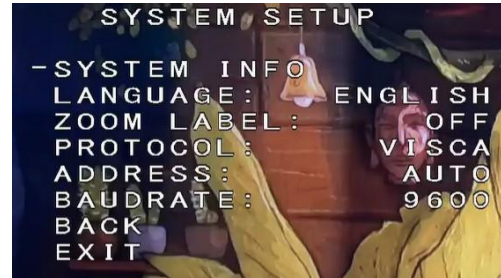

Restore Default

Press the [MENU] button to display the OSD menu, press the arrow keys to move to [DEFAULT], press the right button to make the OSD parameters return to default.

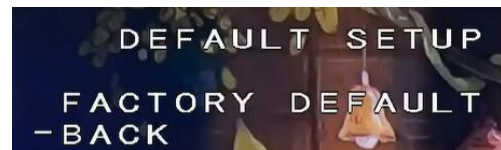



Network Connection

To successfully complete this process, you will need several pieces of information. The first is the IP address of your computer. You will also need to select an unused IP address on your local network (This is the address you will set the camera to). The third piece is the default IP address of your camera. Finally, you will need the IP address of your Default Gateway/Router.

All versions of the BZBGear VPTZ series cameras have the following default IP address:

192.168.1.162

The computer must be on the same subnet as the camera to connect successfully, therefore the computer must be connected to the 192.168.1.x subnet. If your network is already using this IP address subnet, simply enter the cameras' IP address in a web browser to connect. If the current IP subnet is not the same then the computers' network adapter settings must be changed.

- Right-click on the internet connection in the lower right corner of the desktop and select 'Open Network & Internet Settings'.



- Select "Change Adapter Options".

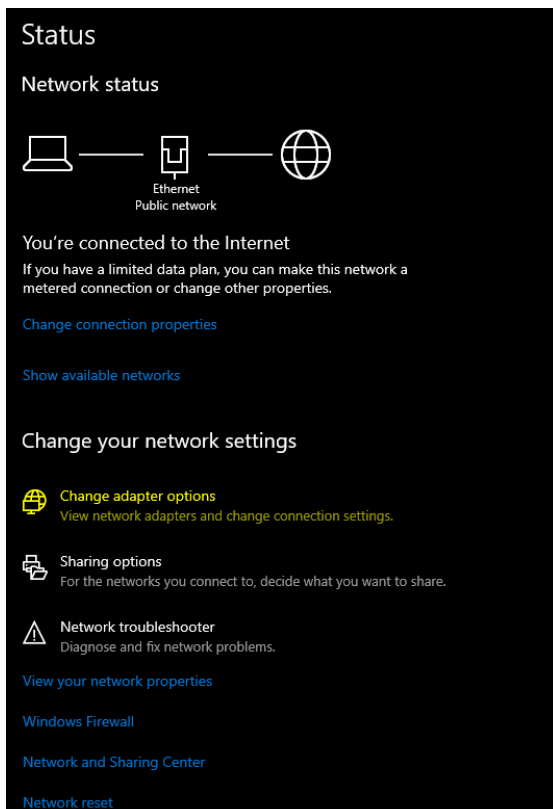



- Right-click on your connection (Wi-Fi or Ethernet) and select 'Properties.'
- Select 'Internet Protocol Version 4 (TCP/IPv4)' as shown below and click 'Properties.'

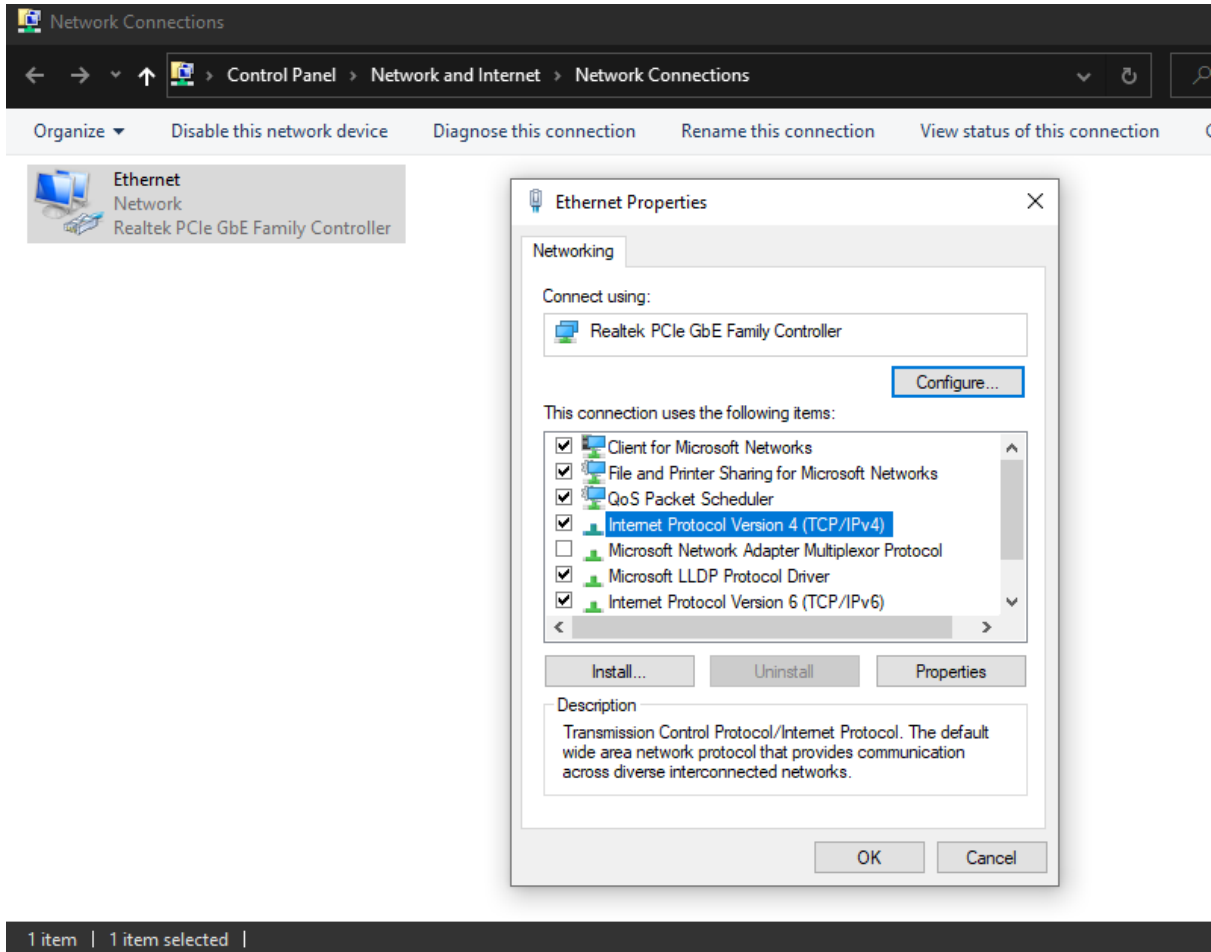

- For the following steps refer to the diagram below. Select 'Use the following IP address.'
- In the IP address field enter a non-conflicting IP address on the same subnet as the camera. If there is another device with the same IP address you will not be able to connect. In the example below we are using 192.168.1.200
- In the Subnet mask field enter 255.255.255.0 In the Default gateway field type 192.168.1.1 You can leave the DNS fields blank.



Internet Protocol Version 4 (TCP/IPv4) Properties

General

You can get IP settings assigned automatically if your network supports this capability. Otherwise, you need to ask your network administrator for the appropriate IP settings.

Obtain an IP address automatically

Use the following IP address:

IP address: 192 . 168 . 1 . 200

Subnet mask: 255 . 255 . 255 . 0

Default gateway: 192 . 168 . 1 . 1

Obtain DNS server address automatically

Use the following DNS server addresses:

Preferred DNS server: 8 . 8 . 8 . 8

Alternate DNS server: 8 . 8 . 4 . 4

Validate settings upon exit

Advanced...

OK Cancel

NOTE: When you are finished configuring the camera you will need to return to this screen and select 'Obtain an IP address automatically' and 'Obtain DNS server automatically' to restore internet connectivity to your computer. Also make sure to reconnect any ethernet cables you may have unplugged.

- Click OK to apply your settings.
- Click OK to close the network properties screen.
- Once you have applied your settings open your web browser and enter the IP address of your camera.
- Enter the **login information** to access the interface.
 - **User: admin / Password: admin**
- At the top left of your screen select 'Config'.



- On the left side of your screen select 'Network'. In the IP address field, you will enter the unused IP address you selected at the beginning. Our example will use an address of 192.168.20.186.
 - *This address MUST NOT be in use by any other device on your network or you will create an IP conflict and be unable to access your camera. ***
- In the 'Subnet Mask' field enter 255.255.255.0 and enter the IP address of your Default Gateway in the field below. Double-check your values and click the Save Button.
- Unless you are given different information by your network administrator you should enter 8.8.8.8 for DNS1 and 8.8.4.4 for DNS2. Click Save.

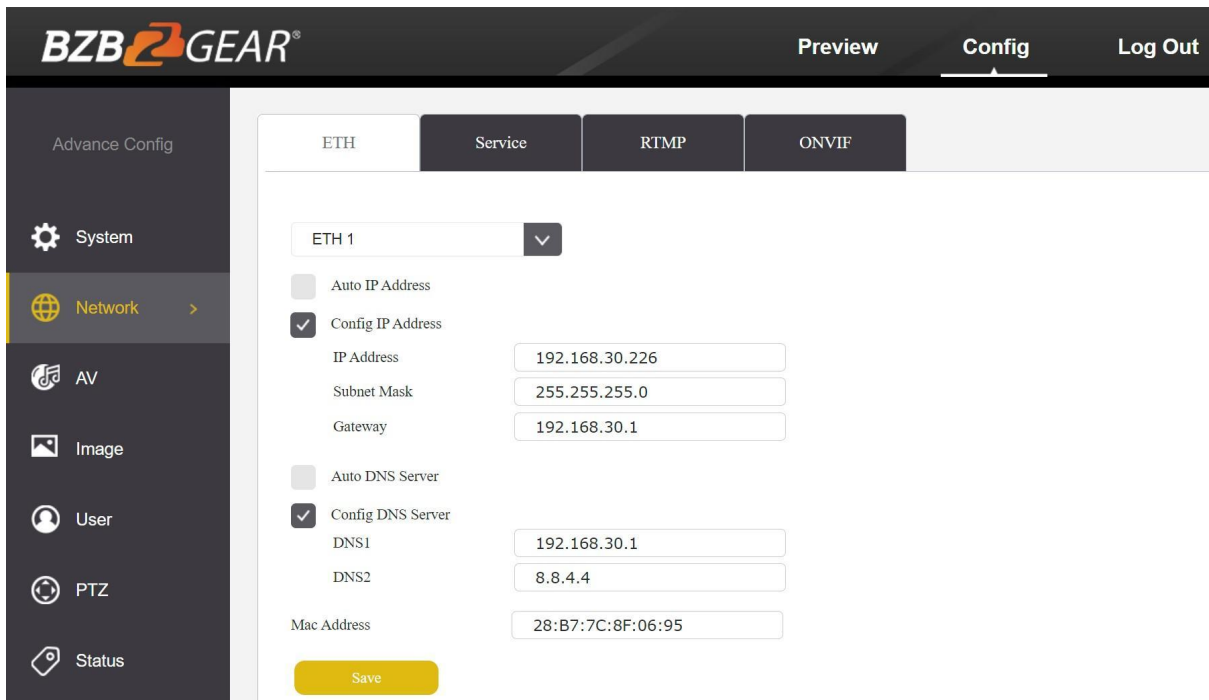

- Once you complete the camera setup, repeat the steps on your computer to adjust ‘Internet Protocol Version 4 (TCP/IPV4) Properties’ and select ‘Obtain IP address automatically’ and ‘Obtain DNS server address automatically.’ Click OK to close all network-related screens.

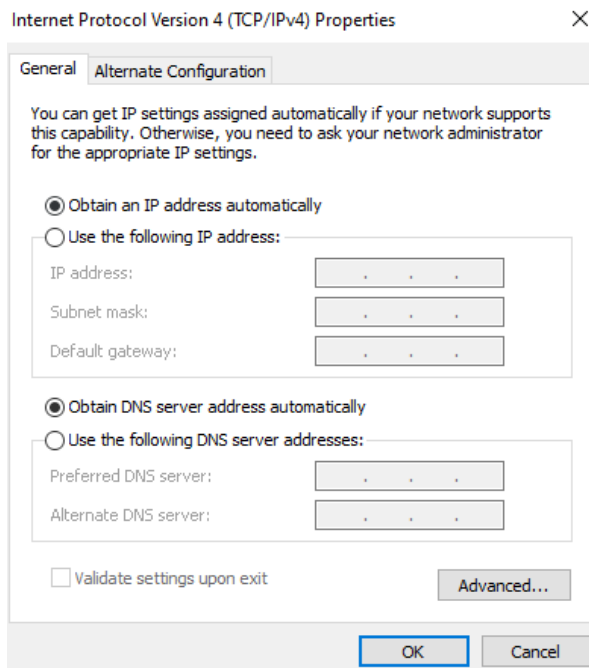

- Your computer and camera should now be on your network. Open your web browser and enter the IP address you assigned to your camera and your setup is complete.



Camera Web Interface

From the Web Interface you can control the camera, view the video feed, and adjust various camera settings and functions.

Preview Screen

From the preview screen you can view the live video feed, preview embedded audio, and adjust PTZ, Focus, and IRIS controls.

Directional Arrows: Use the Up/Down/Left/Right/Diagonal buttons to rotate the camera.



Home Button: Use the Home button to return the camera to the Home position.

Zoom In/Out: Use the Zoom buttons to adjust the zoom level of the camera.

Focus In/Out: Use the Focus buttons to manually adjust the camera's focus.

Speed Control: Use the slider to adjust the PTZ speed of the camera.

Preset Tab: Use the Preset tabs to Set, Recall, and Delete Preset positions. To record a preset, adjust the camera to the desired location and zoom level. Highlight the preset

number you wish to record and click the "Set" button . To recall a preset, highlight the preset number you wish to recall and click the "Call" button . To delete a preset, highlight the preset number you wish to delete and click "Delete" .

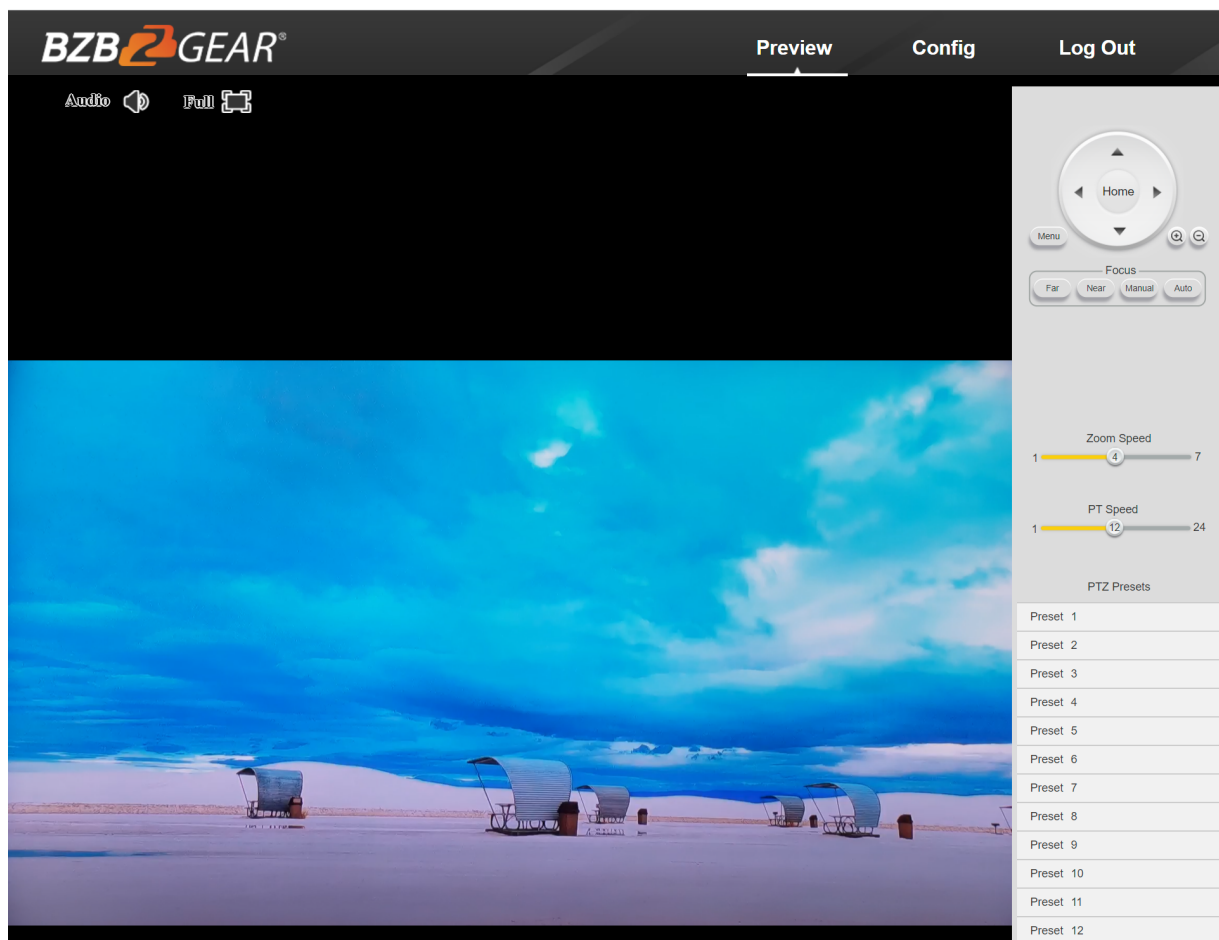



Configuration Screen

From the configuration screen you can set and adjust all the functions and parameters of the camera.

System Page

The system page contains information regarding the camera, time settings, firmware, and main video output resolution.

Version Tab: The version tab contains camera information including model number, serial number, firmware and hardware versions, and MAC address.

Time Tab: The time tab allows you to adjust time, date, and time zone settings.

Maintain Tab: This tab allows you to reboot, restore factory default settings, and update the firmware.

Config Tab: Name the camera, select menu language, select Video Standard (not used), set output resolution, and enable/disable UVC (USB) video output.

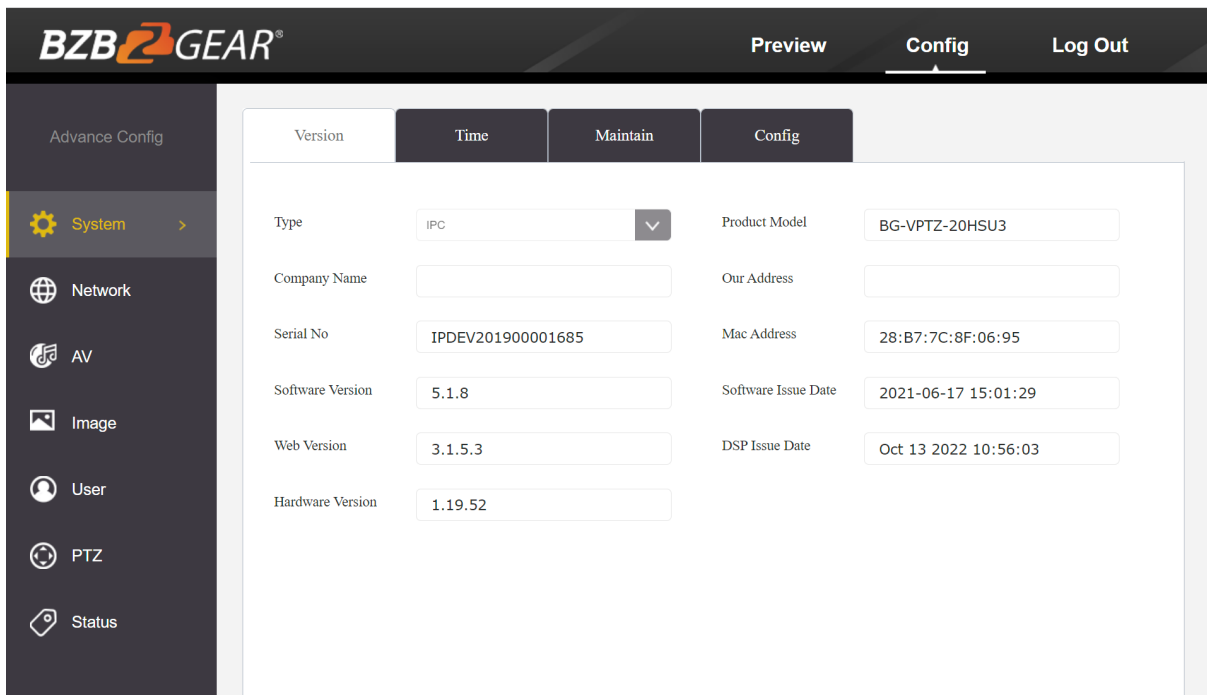



Network Page

The network page includes network settings, port settings, and streaming settings.

ETH Tab: Select static (Config IP Address) or DHCP (Auto IP Address), select Auto or Manual DNS settings.

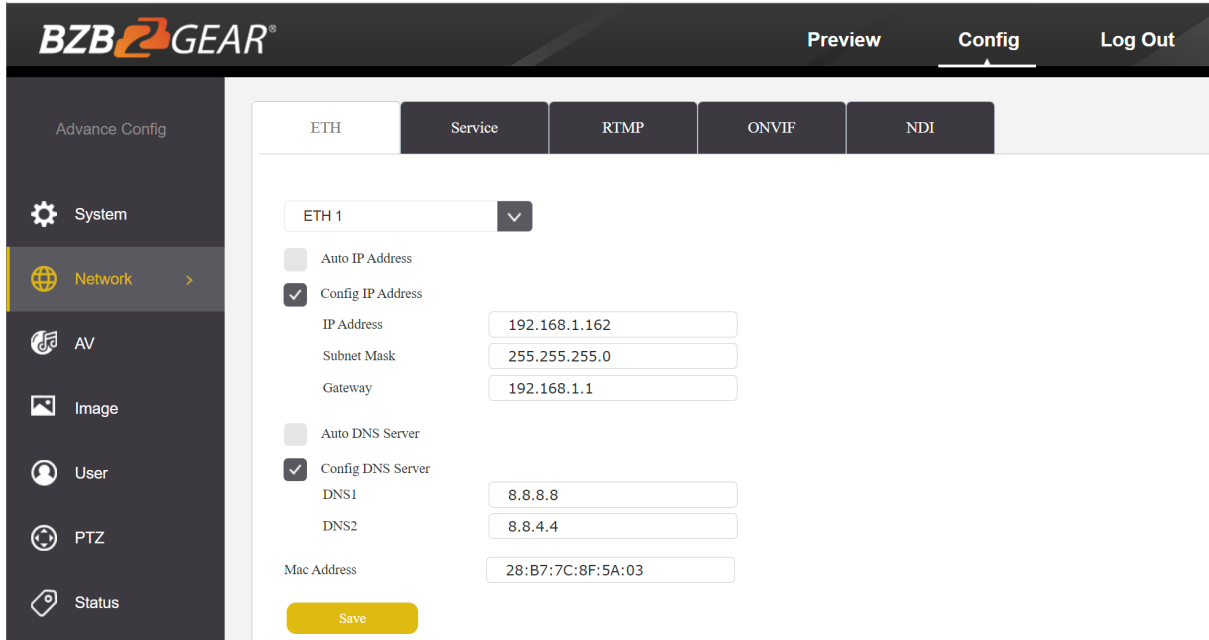

Service Tab

MSG Port: default 8080

RTSP Port: default 554

HTTP Port: default 80

VISCA Port: default 52381

WebSocket Port: default 8880

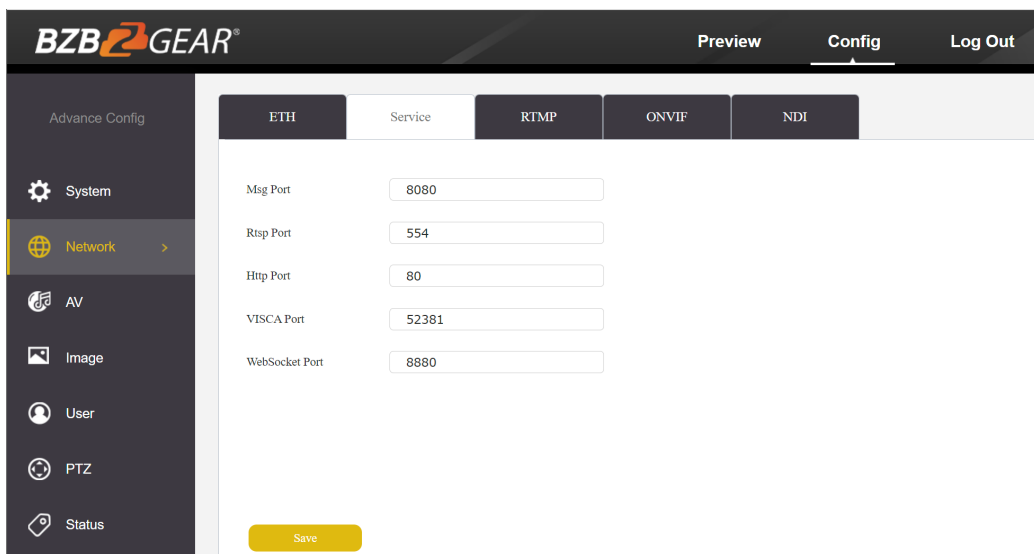

Note: Changing the port number requires restarting the camera to validate the new settings. In order to avoid port conflicts, please be careful to modify.



RTMP Tab

Enable RTMP: (Check box)

Server: Enter the server URL and Stream Key of your streaming platform in the format of :
rtmp://serverURL/StreamKey.

(Ex. rtmp://a.rtmp.youtube.com/live2/du36-z46c-1p31-4kxw-29yx)

Port: Set according to your streaming platform (YouTube=1935, Facebook=443)

Stream Type: Select desired stream

ONVIF Configuration Tab

ONVIF Authentication: Authentication enable, default disable.

ONVIF Server Port: default 8554.

ONVIF RTSP Authentication: Authentication enable, default disable.

RTSP Port: ONVIF RTSP Port, default 8554.



NDI

NDI Enable: NDI enable, default disable.

NDI Name: Used to edit the name of the NDI stream.

NDI Group: public

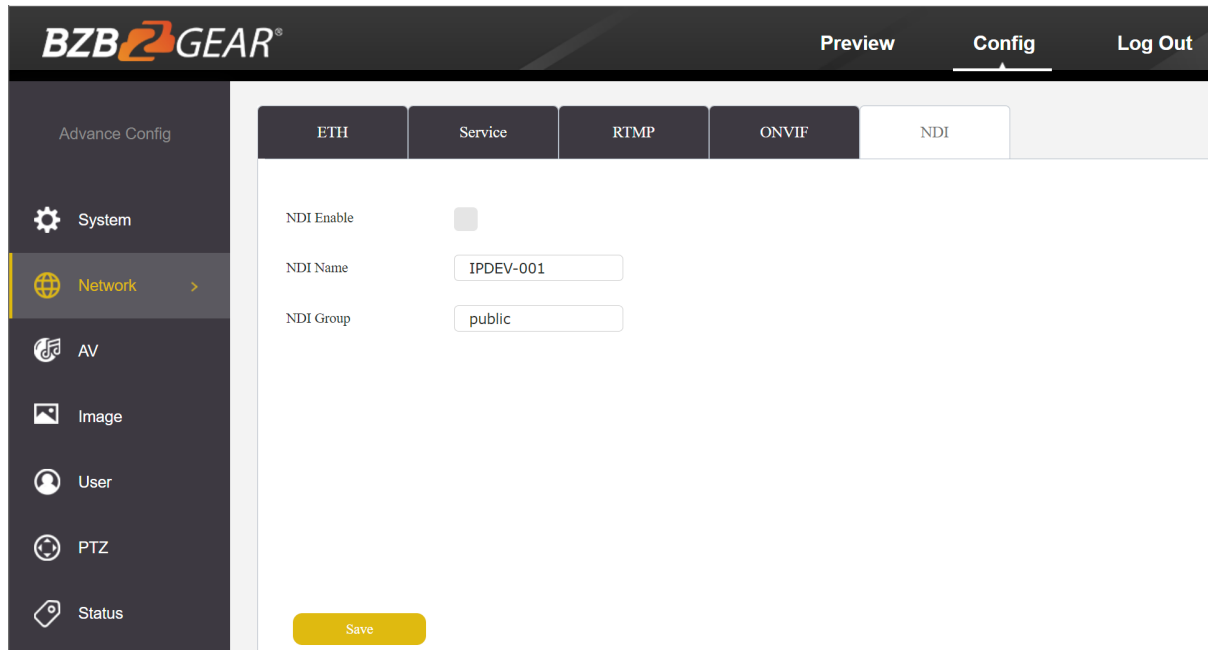

AV Page

The AV page is where you will find all the audio and video settings for stream encoding.

Stream Type: Use the pull-down to select which of the 3 streams you wish to adjust. When you select a stream, all options and settings on the page affect the selected stream.

Stream Key: This shows the address information for your streaming output. This is not adjustable and should be added to the end of your camera's IP address as shown below:

Default Main Stream: rtsp://192.168.1.162:554/0/0/0

Default Sub-Stream: rtsp://192.168.1.162:554/0/0/1

Frame Rate: Specify frame rate (1-30). Frame Rate Priority prioritizes frame rate over image quality when VBR mode is enabled.

GOP: Frame interval (1-60). Default is 30.

Bitrate: Video Bit Rate (1-10240). Default is 4096

Resolution: Set streaming video resolution

Stream Mix Type: Select Complex or Video Stream. Complex Stream includes audio.

Encode Type: Select video encoding format.



Bitrate Type: CBR (Coded Bit Rate), VBR (Variable Bit Rate), Fix QP (Fixed Bit Rate).

- _ When CBR is selected stream quality, IFrame, and PFrame settings are unavailable.
- _ When VBR is selected IFrame and PFrame settings are unavailable.
- _ When Fix QP is selected stream quality setting is unavailable.

Audio Encode Type: Select audio encoding format. AAC is recommended for most streaming platforms.

Audio Input Mode: Select Mic Level or Line Level

Audio Input Gain: Set the audio input gain level (1-10, mute)

Audio Quality: Select High or Low

Covered by one or more claims of the HEVC patents listed at patentlist.accessadvance.com

The screenshot shows the 'Configure' page for BZBGear. The 'Encode' tab is active, displaying the following settings:

Parameter	Value	Parameter	Value
Stream Type	Main	Stream Key	/0/0/0
Frame Rate	30	Encode Level	High Profile
GOP	30	Bitrate Type	CBR
Bitrate(kb/s)	4096	Audio Encode Type	AAC_LC
Resolution	1080P	Audio Input Mode	LINE
Stream Mix Type	Complex Stream	Audio Input Gain	Level 5
Encode Type	H.264	Audio Quality	Low

A 'Save' button is located at the bottom of the configuration area.

Image Page

On the image page you will find all the image, iris, and focus settings for adjusting the camera's picture.

Display Tab

Brightness: Brightness adjustment slider

Contrast: Contrast adjustment slider

Hue: Hue adjustment slider

Saturation: Color saturations adjustment slider

Sharpness: Video sharpness adjustment slider

Mirror: Horizontal image reverse

Flip: Vertical image reverse

Flicker: Lighting flicker compensation

AWB Mode: Auto White Balance Mode settings



BLC: Backlight Compensation adjustment

DNR(3D): 3D Digital Noise Reduction Control

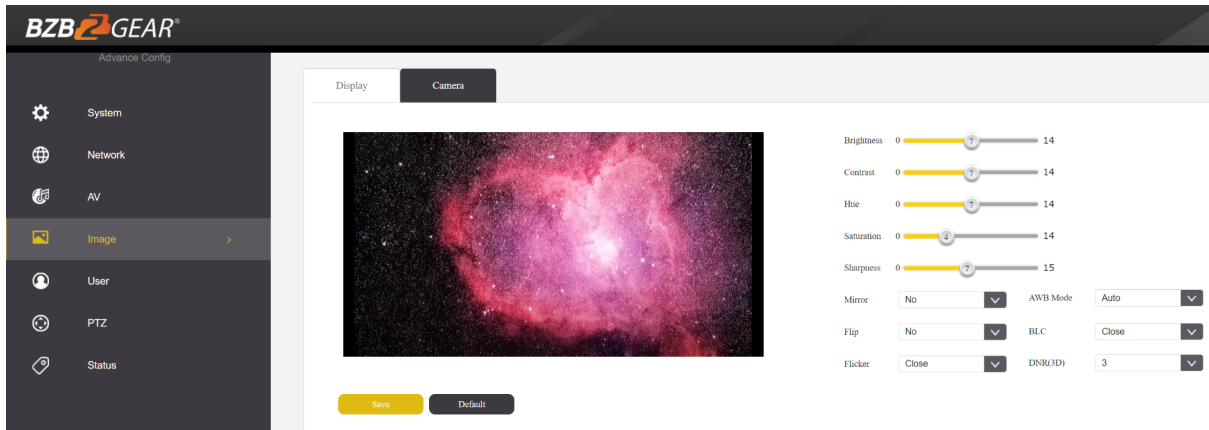

Camera Tab

Focus Mode: Change camera focusing mode

Near Limit: Set the distance from the lens for auto focusing. The camera will not focus on anything closer than the set value.

Sensitivity: Auto focus sensitivity level

ICR Mode: Infrared Cut Filter Removal Mode

AE Mode: Auto Exposure Mode

AE Level: Auto Exposure Level adjustment

HLC: Highlight Compensation Level

DNR(2D): 2D Digital Noise Reduction adjustment

Gamma: Gamma adjustment

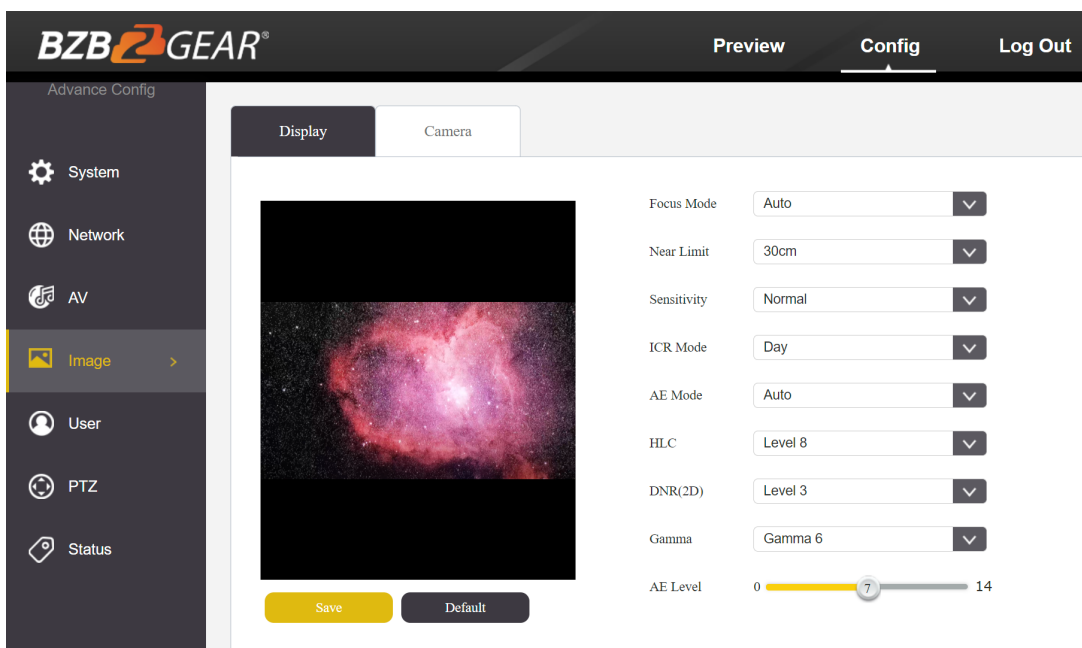



Safety Page

From this screen you can modify the login information

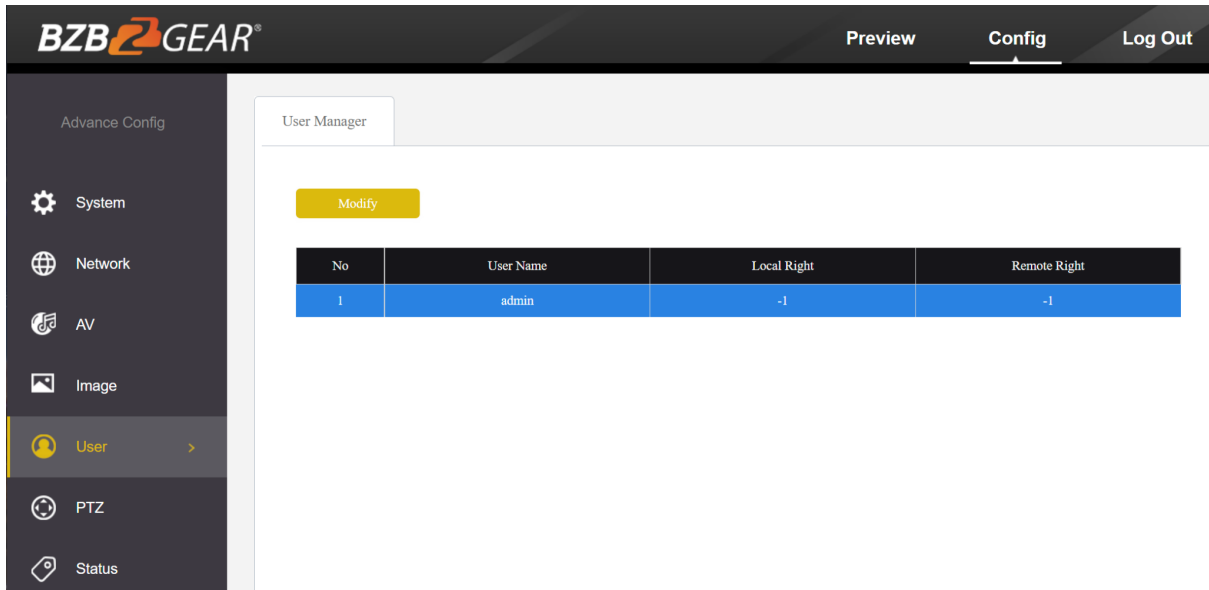

PTZ Page

From this screen you can view and modify the PTZ control settings of the camera.

PTZ Address: Set the PTZ control address of the camera

Protocol: Set the serial control protocol

Baud Rate: Set the serial control baud rate

LR-Direction: Reverse the left and right controls

Vertical Axis: Reverse the up and down controls

Display Mag: Display current magnification (zoom) level

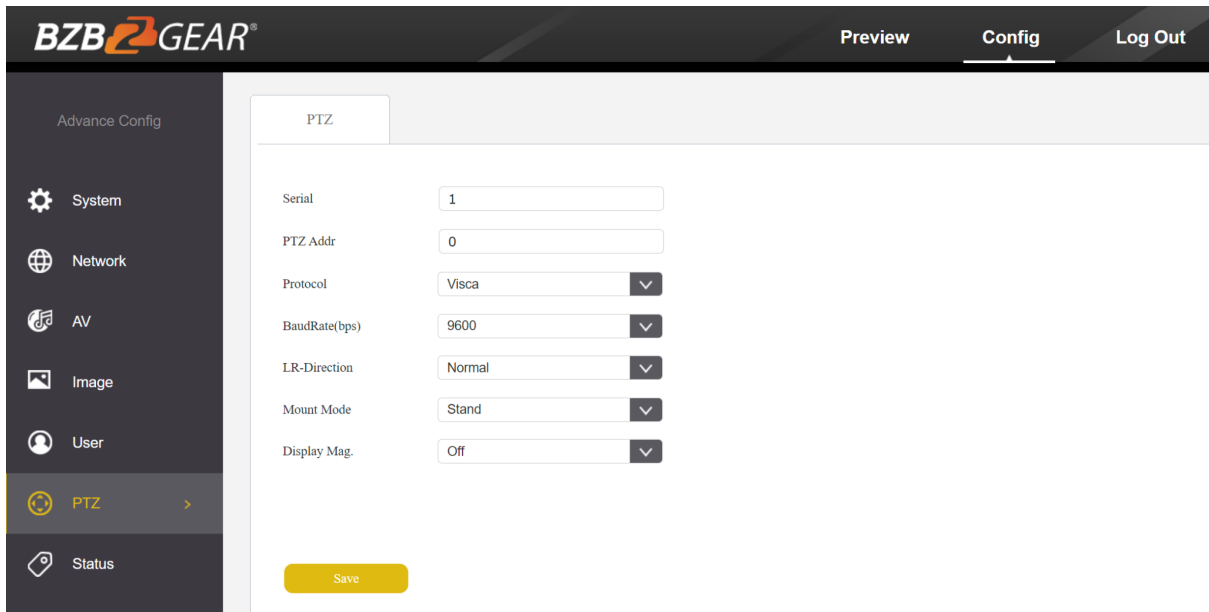



Status Page

On this screen you can view the current bit rates of the 3 IP streams.

No.	Main Stream(kbps)	Second Stream(kbps)	Third Stream(kbps)
1	4197	393	4200

Application Example

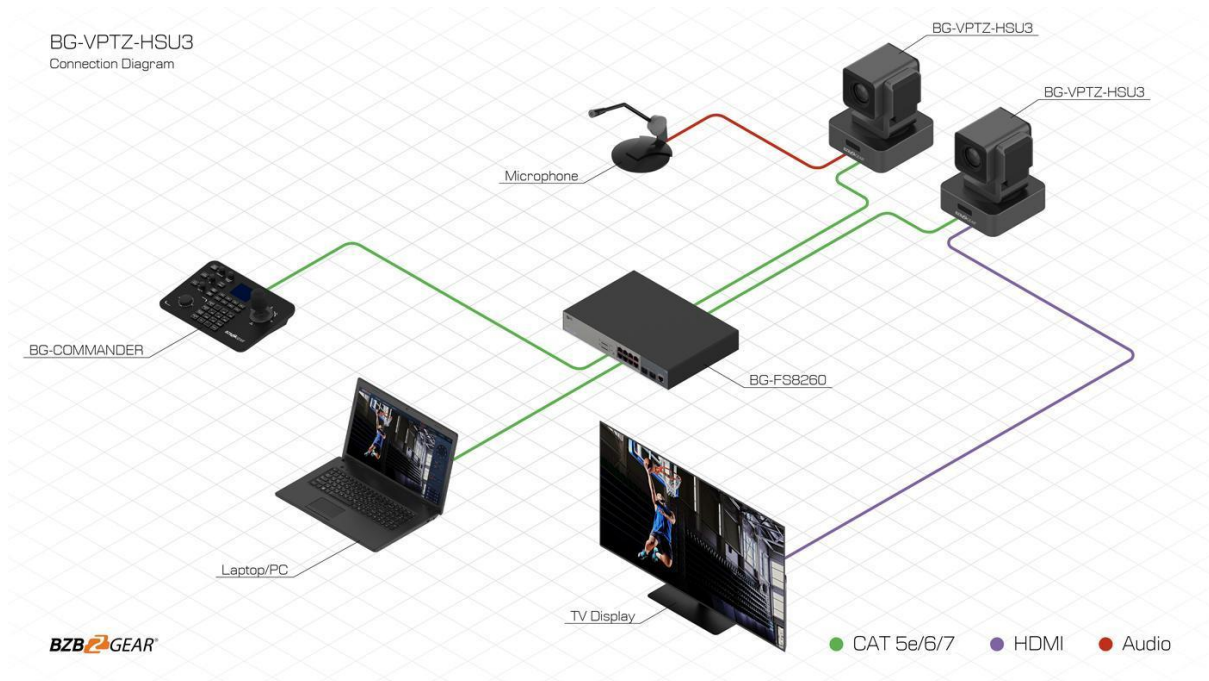



Installation Instructions

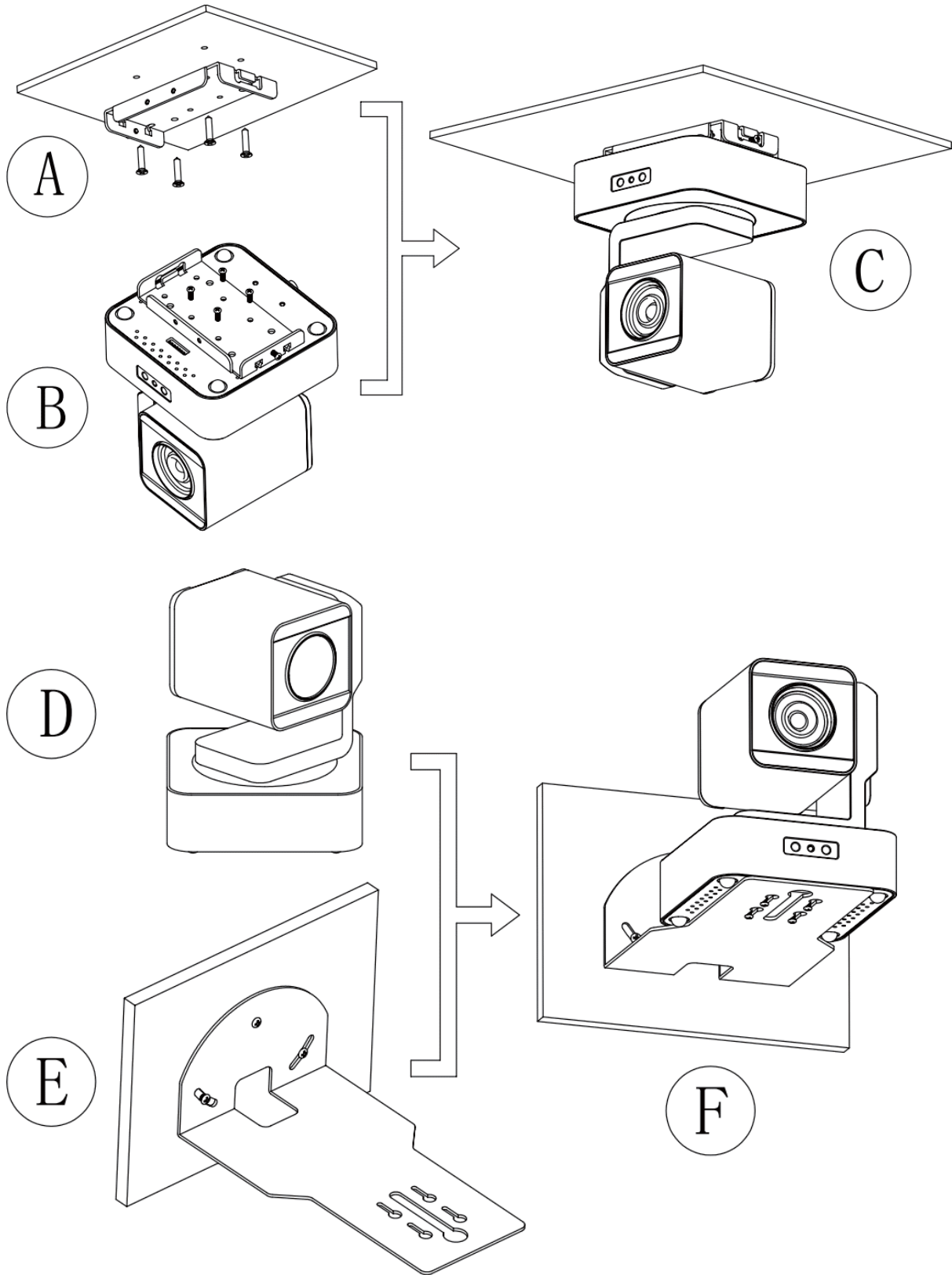



Tech Support

Have technical questions? We may have answered them already!

Please visit BZBGear's support page (bzbgear.com/support) for helpful information and tips regarding our products. Here you will find our Knowledge Base (bzbgear.com/knowledge-base) with detailed tutorials, quick start guides, and step-by-step troubleshooting instructions. Or explore our YouTube channel, BZB TV (youtube.com/c/BZBTVchannel), for help setting up, configuring, and other helpful how-to videos about our gear.

Need more in-depth support? Connect with one of our technical specialists directly:

Phone	Email	Live Chat
1.888.499.9906	support@bzbgear.com	bzbgear.com

Warranty

BZBGear Pro AV products and cameras come with a three-year warranty. An extended two-year warranty is available for our cameras upon registration for a total of five years.

For complete warranty information, please visit bzbgear.com/warranty.

For questions, please call 1.888.499.9906 or email support@bzbgear.com.

Mission Statement

BZBGear is a breakthrough manufacturer of high-quality, innovative audiovisual equipment ranging from AVoIP, professional broadcasting, conferencing, home theater, to live streaming solutions. We pride ourselves on unparalleled customer support and services. Our team offers system design consultation, and highly reviewed technical support for all the products in our catalog. BZBGear delivers quality products designed with users in mind.

Copyright

All the contents in this manual and its copyright are owned by BZBGear. No one is allowed to imitate, copy, or translate this manual without BZBGear's permission. This manual contains no guarantee, standpoint expression or other implies in any form. Product specification and information in this manual is for reference only and subject to change without notice.

All rights reserved. No reproducing is allowed without acknowledgement.